



VECTRON SYSTEMS

Leading in POS Technology



# POS MobilePro III

User manual



Your Vectron dealer

Stamp

Date: 01.12.2017

© 2017 by Vectron Systems AG

Subject to error and technical modification

Manufacturer  
Vectron Systems AG  
Willy-Brandt-Weg 41  
48155 Muenster, Germany  
[www.vectron-systems.com](http://www.vectron-systems.com)

Vectron  
Leading in POS Technology



# Contents

<b>1. Important information.....</b>	<b>11</b>
1.1. Target group of this user manual.....	11
1.2. Dealer support.....	11
1.3. Shipment .....	12
<b>2. Terms, signs and signals .....</b>	<b>13</b>
2.1. Safety-related information .....	13
2.1.1. Warnings .....	13
2.1.2. Warning symbol.....	13
2.1.3. Signal words .....	14
2.2. Notes.....	14
<b>3. Notes on safety.....</b>	<b>15</b>
<b>4. Device description .....</b>	<b>17</b>
4.1. Intended use .....	17
4.2. POS MobilePro III POS system.....	18
4.2.1. Front view .....	18
4.2.2. Brightness sensor.....	23
4.2.3. Tilt sensor.....	23
4.2.4. Rear view .....	24
4.2.5. Battery compartment.....	25
4.2.6. Signaller.....	26
4.2.7. Wireless LAN (WLAN).....	28
4.2.8. Bluetooth .....	28
4.2.9. Transponder module .....	29
4.3. Charging station.....	30
4.4. Battery charging station.....	32
4.5. Power supply Vectron PS80 .....	34
4.6. Y-extension .....	35
4.7. Battery Vectron B60.....	36
4.8. Vectron POS software .....	37

# POS MOBILEPRO III

---

- 5. Technical data ..... 37**
  - 5.1. POS MobilePro III POS system..... 37
  - 5.2. Battery B60 ..... 38
  - 5.3. Charging station..... 39
  - 5.4. Battery charging station..... 39
  - 5.5. Power supply Vectron PS80 ..... 40
  - 5.6. Vectron POS software ..... 41
  - 5.7. Dimensions..... 42
  
- 6. Start-up ..... 46**
  - 6.1. Set-up of charging station or battery charging station..... 46
    - 6.1.1. Selecting the set-up site..... 46
    - 6.1.2. Connecting the charging station to the power supply..... 47
  - 6.2. Inserting the battery to the POS MobilePro III and charging... 48
    - 6.2.1. Inserting the battery..... 48
    - 6.2.2. POS MobilePro III Charging the battery ..... 51
  
- 7. Operation..... 52**
  - 7.1. Switching on and shutting down POS MobilePro III ..... 52
    - 7.1.1. POS MobilePro III switching on ..... 52
    - 7.1.2. Shutting down POS MobilePro III ..... 52
    - 7.1.3. Hardware reset..... 53
  - 7.2. Idle mode..... 54
    - 7.2.1. Switching the Vectron POS MobilePro III to idle mode..... 54
    - 7.2.2. Activating the Vectron POS MobilePro III from idle mode ..... 54
  - 7.3. Sign in to the POS MobilePro III ..... 55
    - 7.3.1. Sign in via operator button ..... 55
    - 7.3.2. Sign in via RFID card ..... 56
  - 7.4. Data input to the POS MobilePro III ..... 56
  - 7.5. Working with guest checks (GC)..... 57
    - 7.5.1. Opening a guest check..... 57
    - 7.5.2. Booking PLUs to a GC..... 58
    - 7.5.3. Closing a GC..... 59
    - 7.5.4. Finalizing a GC..... 59
    - 7.5.5. Separate invoicing of groups or single persons ..... 61
    - 7.5.6. Splitting single PLUs to another guest check..... 62
    - 7.5.7. Moving all PLUs to another guest check ..... 63
    - 7.5.8. Transfer GC..... 63

7.6.	Working with hold buffers.....	64
7.7.	Working with reports.....	64
7.8.	Correction or void last entry.....	64
7.9.	Offline guest checks.....	65
7.10.	Charging and exchanging the battery.....	66
7.10.1.	Charging the battery.....	66
7.10.2.	Charging the battery in the charging station.....	66
7.10.3.	Charging the batteries in the battery charging station.....	66
7.10.4.	Exchanging the battery in the POS MobilePro III.....	69
7.10.5.	Prolonging the battery service life.....	71
7.11.	MicroSD card.....	72
7.11.1.	Inserting the MicroSD card.....	72
7.11.2.	Removing the MicroSD card.....	73
7.12.	WLAN (Wireless Local Area Network).....	73
7.13.	Bluetooth.....	75
7.14.	Print data server.....	76
<b>8.</b>	<b>Service and maintenance.....</b>	<b>77</b>
8.1.	Cleaning.....	77
8.1.1.	Cleaning housing and display.....	77
8.1.2.	Cleaning the keyboard.....	78
8.1.3.	Cleaning the contacts.....	81
8.2.	Contacting the customer service.....	81
<b>9.</b>	<b>Errors, possible reasons and troubleshooting.....</b>	<b>82</b>
9.1.	POS MobilePro III.....	82
9.2.	Charging station.....	86
9.3.	Battery charging station.....	87
9.4.	Power supply failure.....	88
<b>10.</b>	<b>Shutdown.....</b>	<b>89</b>
10.1.	Shutting down the POS MobilePro III.....	89
10.2.	Shutting down charging station or battery charging station...	90
<b>11.</b>	<b>Disposal.....</b>	<b>91</b>
<b>12.</b>	<b>Glossary.....</b>	<b>92</b>

<b>13. Icons.....</b>	<b>94</b>
<b>14. EU Declaration of Conformity .....</b>	<b>96</b>
<b>15. Accessories .....</b>	<b>98</b>
15.1. Battery B60 .....	98
15.2. Charging station.....	99
15.3. Battery charging station.....	100
15.4. Connecting plate .....	100
15.5. Lancom WLAN Access Points .....	101
15.6. Network print licence for WLAN.....	102
15.7. Printer Bixolon SPP-R200II .....	102
15.8. Epson printer TM-P20 WLAN.....	103
15.9. Leather holster.....	104
15.10. Belt.....	105
15.11. Safety strap .....	105
<b>16. Other Vectron products .....</b>	<b>106</b>
16.1. Stationary Vectron POS systems .....	106
16.1.1. Vectron POS Touch 15, POS Touch 15 PCT, POS Touch 15 II PCT.....	107
16.1.2. Vectron POS Touch 12, POS Touch 12 II PCT .....	108
16.1.3. Vectron POS Vario II.....	109
16.1.4. Vectron POS Mini II.....	110
16.2. Software .....	111
16.2.1. Vectron Mobile App.....	111
16.2.2. Vectron Commander.....	112
16.2.3. Vectron Journal Tool.....	113
16.2.4. Vectron POS PC .....	113
16.3. bonVito .....	113







---

# 1. Important information

This user manual is part of the Vectron POS MobilePro III. Please read the whole document and in particular the chapter „Notes on safety“ before working with the product. Keep the document so that it is available for all users at any time. Always enclose the required documents when forwarding the product to others.

## 1.1. Target group of this user manual

End users of the POS MobilePro III.

## 1.2. Dealer support

Your Vectron specialist retailer has programmed the POS MobilePro III for you and is your contact partner for questions concerning the programming. If necessary, he will be happy to support you during initial start-up and will train you in using your POS system.

1.3. Shipment

<b>Vectron MobilePro III POS system</b>	
<b>Standard shipment</b>	Vectron MobilePro III POS system
	One battery Vectron B60
	Vectron POS software with licence as per order
	Notes on safety and installation
<b>Optional accessories</b>	Dispatch box
	11050012 - Leather holster MobilePro
	11050013 - Belt MobilePro
	11050017 - Safety strap Vectron MobilePro
	10260002 - MobilePro III battery charging station (without power supply)
	10260003 - MobilePro III charging station (without power supply)
	10260004 - MobilePro III charging station set (without power supply)
	20090104 - Battery B60
	30010032 - WLAN Access Point Professional

## 2. Terms, signs and signals





### 2.1. Safety-related information

These instructions contain introductory safety information and specific warnings for your POS system POS MobilePro III.

#### 2.1.1. Warnings

<b>⚠ SIGNAL WORD</b>	
	<p><b>Type and source of danger. Consequence of non-compliance</b></p> <p>▶ Averting of a danger</p>

#### 2.1.2. Warning symbol

Warning symbol	Meaning
 	Warning symbols for instructions warning of injuries.
	General warning symbol.
	Warning symbol for hazards due to crushing.
	Warning symbol for hazards due to electric shock.

### 2.1.3. Signal words

**⚠ DANGER**

The signal word „DANGER“ indicates a danger with high risk, which will result in death or severe injury if it is not avoided.

**⚠ WARNING**

The signal word „WARNING“ indicates a danger with medium risk, which could result in death or severe injury if it is not avoided.

**⚠ CAUTION**

The signal word „CAUTION“ indicates a danger with low risk, which could result in minor injuries if it is not avoided.

**NOTICE**

The signal word „NOTICE“ indicates a danger which could result in material damage if it is not avoided.

### 2.2. Notes



This sign refers to information that can be helpful when operating your POS MobilePro III.

### 3. Notes on safety

#### **⚠ DANGER**

**Deadly shock caused by damaged POS system components.**

- ▶ Disconnect the mains cable from the power grid in case of damage. Contact your Vectron specialist retailer if POS system components are damaged.

#### **⚠ CAUTION**

**Risk of stumbling and damaging the POS system components by device cables lying unprotected in the room.**

- ▶ Route the device cables so that they do not pose a potential hazard!

#### **NOTICE**

**Damage of POS system components caused by excessively high voltages or currents.**

- ▶ Use an earthed socket to which alternating current between 110 and 240 volts is connected. Use power sources which are protected with a residual-current circuit breaker.

**Damage of charging station or battery charging station caused by unsuitable batteries.**

- ▶ Please use exclusively Vectron-approved batteries for the POS MobilePro III.

**Damage of touch screen through unsuitable objects.**

- ▶ Please touch the screen exclusively with fingers or the provided stylus.

### NOTICE

#### **Burn-in effect through static image content.**

Shadow images can remain visible on the display due to static image content.

- ▶ Please configure the screen saver.
- ▶ Your Vectron dealer will support you should you have questions on programming or will program the POS system according to your requirements.

#### **Malfunctions caused by faulty programming.**

- ▶ Only change the programming when your are absolutely sure of the effects this will have.
- ▶ Protect the programming and program functions by means of passwords.
- ▶ Your Vectron specialist retailer will support you should you have questions on programming or will program the POS system according to your requirements.

#### **Aggressive cleansers can damage the housing surface.**

- ▶ Do not use any scouring or dissolving agents for cleaning.
- ▶ If necessary clean the housing surface with a smooth, lintfree cloth. In case of strong contamination you can dampen the cloth with water or with a mild, residue-free cleanser.

#### **Damage to POS system components when transporting in unsuitable packing.**

- ▶ Only transport the POS system and the power supply unit in the original packing.



---

## 4. Device description

### 4.1. Intended use

The POS MobilePro III is a mobile POS system for order taking and payment.

The POS MobilePro III may be used under ambient conditions as defined in chapter 5.1 “POS MobilePro III POS system” on page 37.

Operate the charging station and the battery charging station exclusively indoors and under ambient conditions as defined in in chapter 5.3 “Charging station” on page 39 and in chapter 5.4 “Battery charging station” on page 39.

Operation of the POS MobilePro III is exclusively allowed with Vectron original accessories or Vectron-approved accessories.

The Vectron Systems AG does not accept liability for damages or injuries resulting from improper use.

Please observe the regulations of the professional organizations.

The operating company of the POS MobilePro III is responsible for saving and backup of data that was created with the POS MobilePro III.

The operating company of the POS MobilePro III is responsible for processing the data in accordance with the legal demands.

## 4.2. POS MobilePro III POS system

The housing of the POS MobilePro III is shock- and waterproof.

### 4.2.1. Front view



Fig. 1: POS MobilePro III Front view

Pos.	Designation	Description
1	Status LEDs (on upper edge of the POS system)	Show the operating status.
2	Brightness sensor	Measures the ambient light for regulation of screen- and keyboard brightness.

Pos.	Designation	Description
3	Display with touch screen	Screen with touch-sensitive surface for data input.
4	Keyboard	Data input

#### 4.2.1.1. Touch screen (example configuration)

The colour display shows 256 colours with a resolution of 480 x 640 pixels.

<b>NOTICE</b>	
	<p><b>Damage of touch screen caused by unsuitable objects.</b></p> <p>► Touch the screen exclusively with the provided stylus or with your fingers.</p>

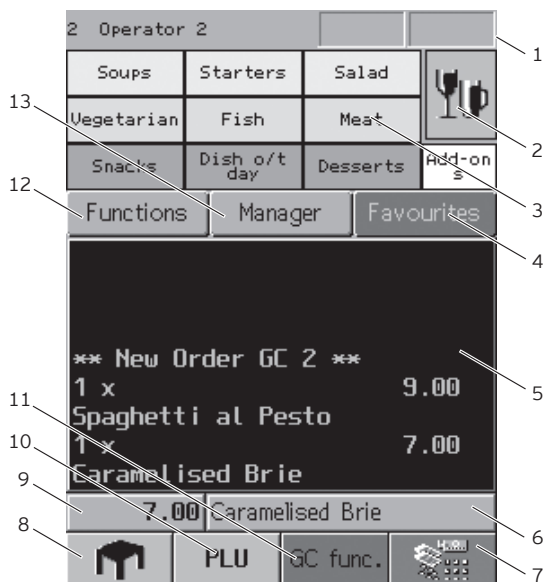



Fig. 2: Registration interface

Pos.	Designation	Description								
1	Status display	<p>In the status display you can show the logged-in operator, the WLAN signal strength, the battery charging status, date and time. The battery charging status can display the following:</p> <table border="1"> <tr> <td>green</td> <td>&gt; 30 percent charged</td> </tr> <tr> <td>yellow</td> <td>&lt; 30 percent charged</td> </tr> <tr> <td>red</td> <td>&lt; 15 percent charged</td> </tr> <tr> <td>red frame</td> <td>Charging error. Please mind the error message.</td> </tr> </table> <p>An arrow in the display of the battery charging status indicates that the battery is being charged.</p>	green	> 30 percent charged	yellow	< 30 percent charged	red	< 15 percent charged	red frame	Charging error. Please mind the error message.
green	> 30 percent charged									
yellow	< 30 percent charged									
red	< 15 percent charged									
red frame	Charging error. Please mind the error message.									
2	Main groups	Food or drinks.								
3	Department selection	Subgroups of the respectively selected main group.								
4	Favourites	Selected products can be added to the list of favourites.								
5	Receipt-, invoice- and GC display	The receipt-, invoice- and GC display shows e.g. PLU bookings, a customer's invoice and the bookings of an open guest check.								
6	Info field	This field shows e.g. information on the media or a GC number.								
7	Media	Click on this button to open the selection of various media. You also select here whether a receipt is printed or not.								
8	GC	To open a GC please select the respective number and press the GC button.								
9	Input field	Display of data entered via keyboard.								
10	PLU	Booking by entering the PLU no.								
11	GC function	Various, GC-related functions.								
12	Functions	General operator functions.								

Pos.	Designation	Description
13	Manager	Options for various administrative functions.

#### 4.2.1.2. Keyboard

Via the keyboard of the POS MobilePro III you can control POS system functions and enter data.

	<p>To some keys you can assign individual functions. Your Vectron specialist retailer will support you with the programming of required functions.</p>
-----------------------------------------------------------------------------------	------------------------------------------------------------------------------------------------------------------------------------------------------------

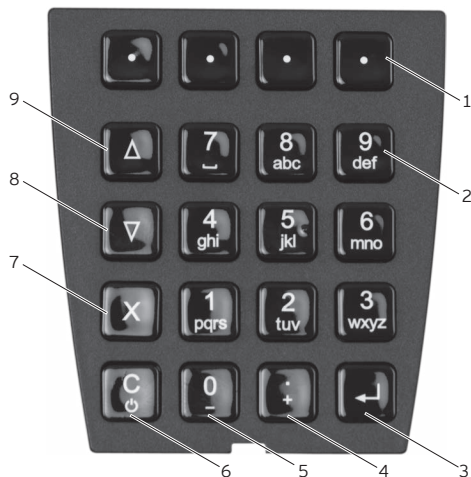

Fig. 3: Keyboard

## POS MOBILEPRO III

---

Pos.	Designation	Description
1	Softkeys	Four softkeys can be allocated individual functions.
2	Numeric keys	You can use the numeric key for input of numbers or alphanumeric shortcuts.
3	Input key	Confirm data entry or menu item.
4	Input of decimal or increase select count	Depending on the context you either enter a decimal or increase the select count by one digit.
5	Numeric key or reduce select count	Depending on the context you either enter 0 or reduce the select count by one digit.
6	Correction- or On-/Off key	<ul style="list-style-type: none"> <li>• If the POS MobilePro III is switched off, you can start it by shortly pressing this key.</li> <li>• If the POS MobilePro III is switched on, you delete the complete entry by shortly pressing this key.</li> <li>• Pressing the key for at least two seconds switches the POS MobilePro III to idle mode.</li> </ul>
7	Multiplication key or Escape	Depending on the context you either enter a multiplier or you cancel an operation.
8	Scroll down	Scrolls one line down.
9	Scroll up	Scrolls one line up.



In addition to softkeys the keys of pos. 2 to 9 can also be assigned individual functions.

### 4.2.2. Brightness sensor

The display backlight and the keyboard lighting can be adjusted automatically to the ambient light (dimmed) with the respective programming.

For precise and bright display under different ambient conditions you can preset profiles.

Your Vectron specialist retailer will present you the profiles and other configuration options if requested.

### 4.2.3. Tilt sensor

An integrated tilt sensor recognizes changes of the horizontal position.

With respective programming the screen will rotate by 180° when tilting the display downwards.

You can program the POS MobilePro III so that it switches to a different layout format for a clearer display. You can thus show your customers the invoice items for example.

You can program the POS MobilePro III so that it activates a power save mode in vertical position. The tilt sensor ends the power save mode when you bring the POS MobilePro III to an almost horizontal position.

4.2.4. Rear view

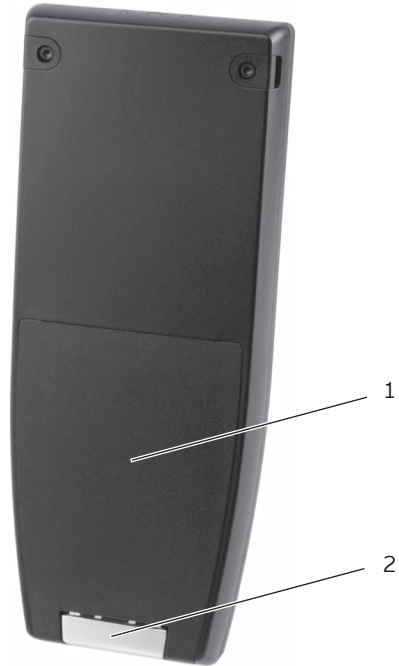

Fig. 4: Rear view of the POS MobilePro III

Pos.	Designation	Description
1	Battery compartment lid	The battery compartment lid closes the housing of the POS MobilePro III waterproof.
2	Battery compartment lid locking	Mechanism to close the battery compartment lid.



## 4.2.5. Battery compartment

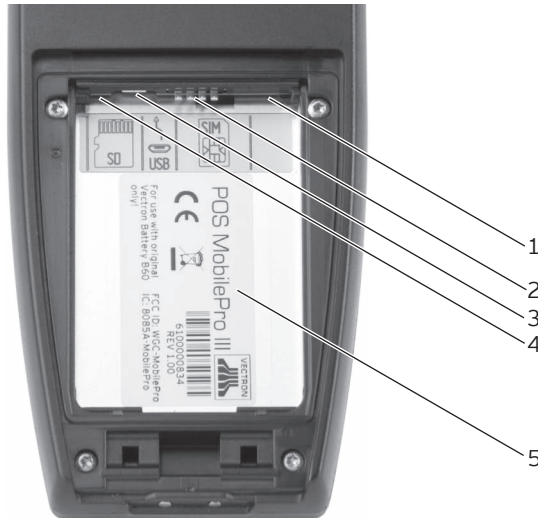

Fig. 5: Battery compartment of the POS MobilePro III

Pos.	Designation	Description
1	Card reader	Smartcard reader
2	Charging contacts	The battery is inserted correctly when the contacts apply here.
3	MicroUSB port	Port for service purposes.
4	MicroSD card reader	Here you can insert a MicroSD card for data update or program update.
5	Label	The label contains the product designation and the serial number of the POS MobilePro III.

### 4.2.6. Signaller



The operating status indicated by the signallers depends on the programming of your POS MobilePro III. You can combine the signals of status LED, buzzer and vibration motor.

#### 4.2.6.1. Charge state

The POS MobilePro III can give various signals to indicate that the inserted battery weakens and should be exchanged.

You can configure different optical and acoustic signals. During operation you can fade in a permanent charge state display in the form of a bar, which indicates the battery's capacity. The charge state can also be displayed in percent.

If desired, your Vectron specialist retailer will configure this according to your request.

#### 4.2.6.2. Status LEDs

On the upper edge of the POS MobilePro III there are two status LEDs.

- Status LED 1 shines green or red.
- Status LED 2 shines blue.

The default setting signals the following operating status.

Colour		Interval	Status
blue		flashing	The POS MobilePro III has received a message.
green		flashing	The POS MobilePro III is in the charging station and the battery is being charged.
green		permanent	The POS MobilePro III is in the charging station. The battery is charged completely.
green		slowly flashing	The POS MobilePro III is in idle state.
red	blue	permanent	On-/Off key and right softkey are pressed to switch off the POS MobilePro III.

#### 4.2.6.3. Acoustic signaller

The POS MobilePro III has an installed buzzer. It is suited for acoustic output of hints and warnings.

#### 4.2.6.4. Vibration motor

The integrated vibration motor serves for silent signalling.

## 4.2.7. Wireless LAN (WLAN)

The POS MobilePro III has a WLAN module for wireless network communication.  
Your Vectron specialist retailer will support you with the WLAN installation and programming of required functions. (cf.in chapter 7.12 “WLAN (Wireless Local Area Network)” on page 73)

## 4.2.8. Bluetooth

The integrated Bluetooth radio module serves for communication with peripherals. Via this radio connection the POS MobilePro III can contact printers, scanners etc.

The range of this connection is about five metres. Obstacles reduce the range or can interrupt the connection.



Using the Bluetooth module requires an additional licence. Please contact your Vectron dealer.

Your Vectron specialist retailer will support you with the Bluetooth installation and programming of required functions.

#### 4.2.9. Transponder module

The POS MobilePro III has an installed transponder module.

Via the transponder module operators can log in to the POS system and customer cards can be read.

The transponder module serves for contactless reading and writing of RFID cards when these are approached to the rear of the POS MobilePro III.

Your Vectron specialist retailer will support you with the programming of required functions.

### 4.3. Charging station

When the POS MobilePro III is in the charging station the inserted battery is being charged.



Fig. 6: Charging station top view

Pos.	Designation	Description
1	Holder	
2	Charging station contacts	The inserted battery is charged via the charging station contacts of the POS MobilePro III.

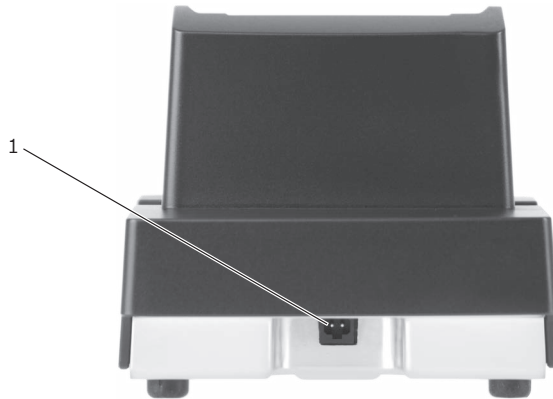

Fig. 7: Charging station rear view

Pos.	Designation	Description
1	Power connection	The plug of the power supply Vectron PS80 is plugged to the power connection.

#### 4.4. Battery charging station

Battery charging stations for the charging of replacement batteries are optionally available.









Fig. 8: Battery charging station front view

Pos.	Designation	Description
1	Charging contacts	The battery is charged via the charging contacts.
2	Operational readiness	The display shows the progress of charging, the capacity of the inserted batteries and possible disturbances.



## Elements of the charge indicator

Symbol	Description
	Power supply connected. Ready for operation.
	Batteries inserted.
	Display of charging activity. The number of green bars indicates the charging state. The upper bar blinks as long as the battery is not completely charged.
	Battery left in good condition. Battery right with restricted capacity.
	Battery left damaged.
	Battery left communication error. Clean the charging contacts at the battery charging station and the battery contacts.
	Battery left temperature warning. Outside a temperature range of ca. 5° to 40° C the battery charging station interrupts the charging. The charging is continued automatically when the temperature is adjusted.

#### 4.5. Power supply Vectron PS80



Fig. 9: Power supply Vectron PS80

Pos.	Designation	Description
1	Label	Technical data and the serial number of the power supply Vectron PS80 are printed on the label.
2	Power supply plug	The power supply plug is put into the power connector of the charging station.

## 4.6. Y-extension

If requested you can connect several charging stations or battery charging stations.

One power supply Vectron PS60 or Vectron PS61 is required for max. two stations.



Fig. 10: Y-extension for connection of two stations

Pos.	Designation	Description
1	Power supply plug	The plugs are connected to the power supplies of the stations.
2	Connector for power supply plug	The plug of the power supply Vectron PS60 or PS61 is connected here.

#### 4.7. Battery Vectron B60



Fig. 11: Grip



Fig. 12: Battery contacts

Pos.	Designation	Description
1	Grip	At the grip you can take the battery out of the POS MobilePro III.
2	Label	Technical data and the serial number of the power supply battery Vectron B60 are printed on the label.
3	Battery contacts	Via the battery contacts you charge the battery or supply the POS system with power.

#### 4.8. Vectron POS software

The POS MobilePro III is supplied with Vectron POS software. The usable functions depend on the applied software version and the programming (more information to be found in chapter 7 "Operation" on page 52).

## 5. Technical data

### 5.1. POS MobilePro III POS system

Technical data of the MobilePro III POS system	
<b>Display</b>	8.89 cm (3.5") TFT-LCD with Blanview technology (low power consumption and excellent outdoor legibility)
<b>Lighting</b>	LED-backlight
<b>Display size (active)</b>	53.2 x 71 mm; active
<b>Resolution</b>	480 x 640 pixel
<b>Colours</b>	Up to VPOS version 5.x: 256 colours; As of VPOS version 6.0.0.0: True Color
<b>Input</b>	capacitive touch screen and keyboard
<b>Housing</b>	two-part, aluminium and PC-plastic (shock- and waterproof)
<b>Processor</b>	Marvel PXA 168, 1066 MHz
<b>Main memory</b>	512 MB DDR2-SRAM
<b>Cache</b>	1 MB SRAM
<b>Mass storage</b>	4 GB Flash memory
<b>Ports</b>	WLAN, Bluetooth, Micro-SD card, Micro-USB, Chip card
<b>Wireless LAN</b>	IEEE 802.11b/g/n (safety standard: WEP/WPA2-PSK)
<b>Bluetooth</b>	2.0
<b>Transponder</b>	TagIt, prepared for use of Mifare cards
<b>Audio</b>	buzzer

Technical data of the MobilePro III POS system	
<b>Tilt sensor</b>	three-axes-tilt sensor
<b>Battery compartment lid sensor</b>	detection of open battery compartment lid
<b>Vibration alarm</b>	integrated
<b>Power supply</b>	lithium-polymer battery with 3000 mAh
<b>Buffer battery</b>	for permanent power supply of cache
<b>Power consumption</b>	7.5 W in normal operation; 0.03 W in standby
<b>Temperature</b>	storage: -20 to 70 °C operation: -10 to 50 °C
<b>Air humidity</b>	10 to 80 %, non condensing
<b>Dimensions (W x H x D)</b>	75 x 183 x 22 mm
<b>Weight</b>	240 g without battery
<b>Certified</b>	CE

## 5.2. Battery B60

Technical data of the battery B60	
<b>Type</b>	Lithium-polymer battery
<b>Charging capacity</b>	3000 mAh
<b>Voltage</b>	3.7 V
<b>Temperature</b>	storage: -20 to 35°C charging: 5 to 40°C cell temperature discharging: -10 to 60°C cell temperature
<b>Air humidity</b>	45 to 85 %, non condensing
<b>Service life</b>	ca. 500 charge cycles
<b>Dimensions (W x H x D)</b>	46 x 68 x 12.6 mm
<b>Weight</b>	70 g

### 5.3. Charging station

Technical data of the charging station	
<b>Input voltage</b>	permissible supply voltage 12 - 24V
<b>Power consumption</b>	8 W in normal operation; 0.5 W in standby
<b>Temperature</b>	operation: 0° - 40°C (the battery in the POS system can only be loaded as of 5°C for safety reasons)
<b>Dimensions (W x H x D)</b>	103.7 x 93.4 x 121.4 mm
<b>Weight</b>	ca. 400 g
<b>Certified</b>	CE

### 5.4. Battery charging station

Technical data of the battery charging station	
<b>Input voltage</b>	permissible supply voltage 12 - 24V
<b>Power consumption</b>	18 W in normal operation; 0.9 W in standby
<b>Temperature</b>	operation: 0° - 40°C (charging of batteries as of 5°C for safety reasons)
<b>Dimensions (W x H x D)</b>	128.7 x 45 x 121.1 mm
<b>Weight</b>	ca. 489 g
<b>Certified</b>	CE

5.5. Power supply Vectron PS80

Technical data of power supply Vectron PS80	
<b>Input voltage</b>	100 to 240 V alternating voltage
<b>Output voltage</b>	+ 24 V direct voltage
<b>Output current</b>	max. 1.67 A
<b>Output power</b>	max. 40 W
<b>Power consumption</b>	max. 44 W
<b>No-load loss</b>	max. 0.3 W
<b>Temperature</b>	storage: -40 to 85 °C operation: -30 to 60 °C
<b>Air humidity</b>	90 %, non condensing
<b>Dimensions (W x H x D)</b>	125 x 32.5 x 50 mm
<b>Weight</b>	280 g
<b>Certified</b>	CE, UL



## 5.6. Vectron POS software

Technical data of Vectron POS software	
<b>PLUs</b>	1,000,000*
<b>Departments</b>	65,535*
<b>Operators</b>	2,000*
<b>Guest checks/ customers</b>	65,535*
<b>Cash registers per network</b>	200*
<b>Printers per network</b>	100*
<b>User interface as of VPOS version 6.0.0.0</b>	Gesture recognition (swipe) for fast navigation
	Use of own images and icons also with transparency channel
	Unrestricted support of the bonVito online marketing tool (liable to costs - more information and prices at <a href="http://www.bonvito.net">www.bonvito.net</a> )
<b>bonVito</b>	Unrestricted support of the bonVito online marketing tool (liable to costs - more information and prices at <a href="http://www.bonvito.net">www.bonvito.net</a> )

\* The indicated values are maximum values, which can only be reached with special programming and optimum hardware equipment. Please contact your Vectron dealer to assist you with your special requirements.

5.7. Dimensions

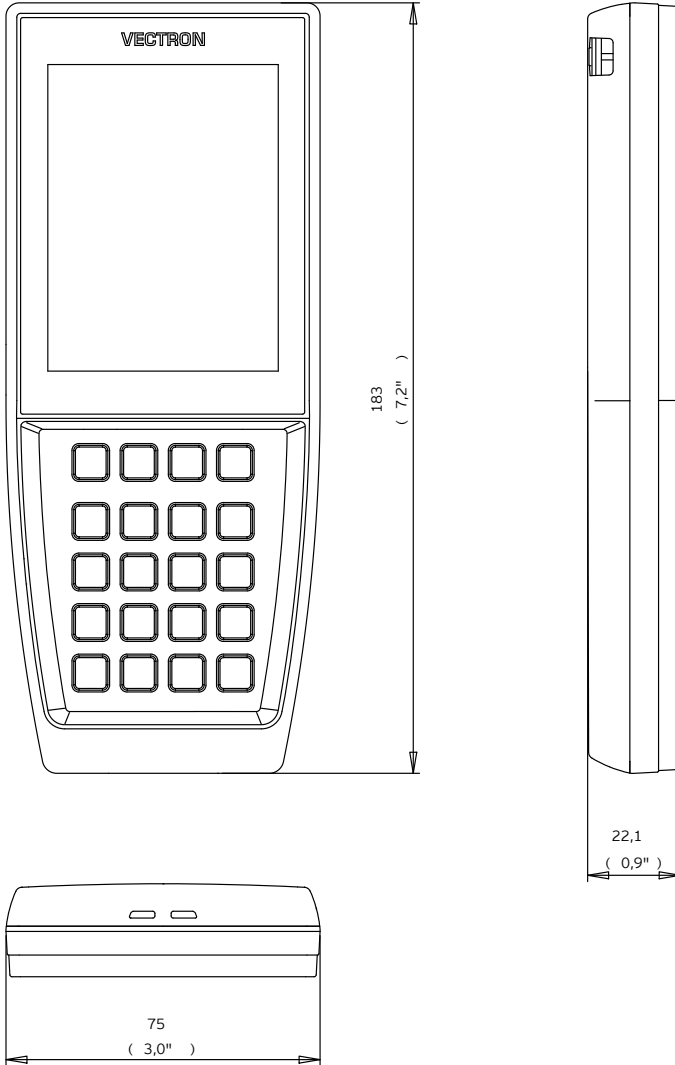

Fig. 13: POS MobilePro III (in mm and inch)

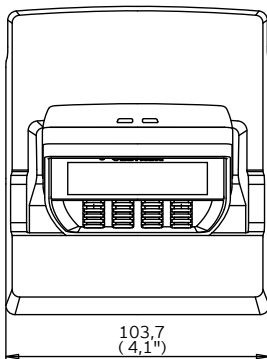
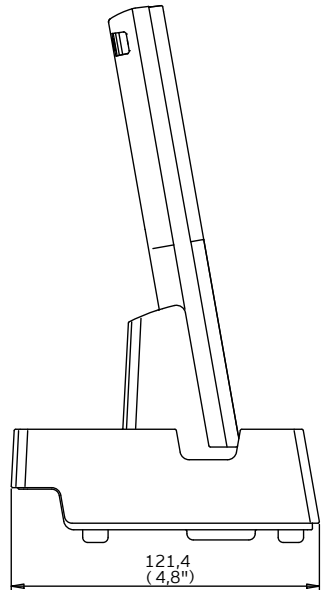
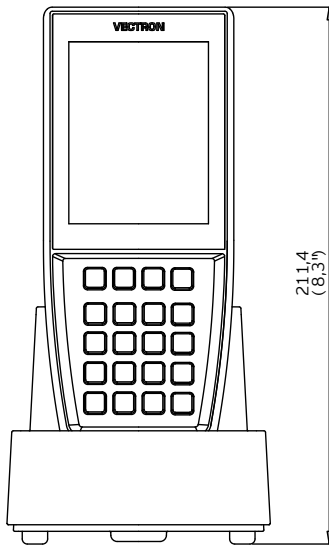

Fig. 14: Total height POS MobilePro III in charging station  
(dimensions in mm and inch)

# POS MOBILEPRO III

---

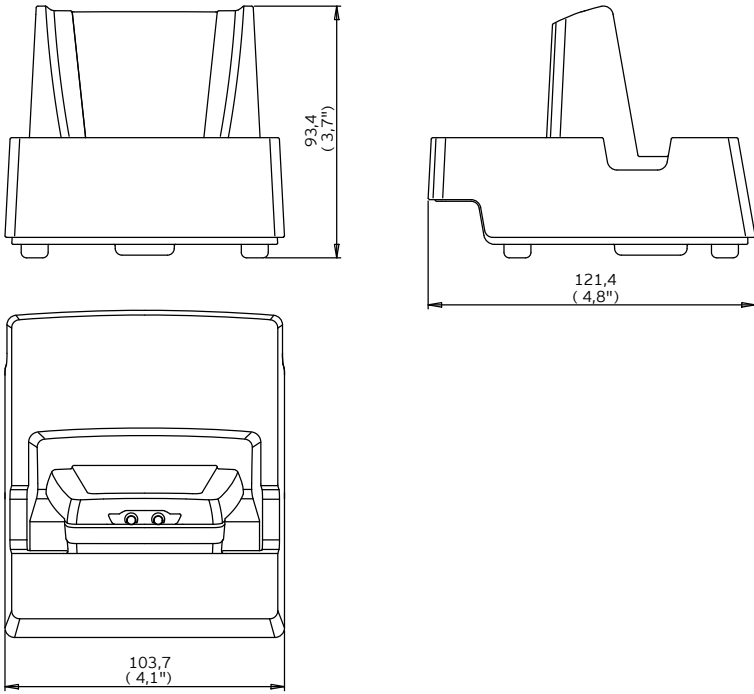

Fig. 15: Charging station (dimensions in mm and inch)

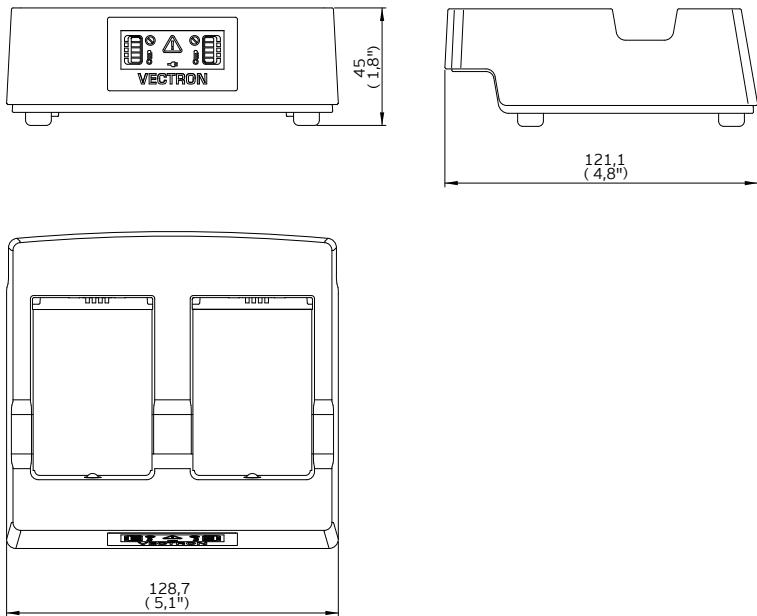

Fig. 16: Battery charging station (dimensions in mm and inch)

# 6. Start-up

Your Vectron specialist retailer has programmed the POS MobilePro III for you. If necessary, he will be happy to support you during initial start-up and will train you in using your POS system.

## 6.1. Set-up of charging station or battery charging station

### 6.1.1. Selecting the set-up site

- Set up the charging station or battery charging station in a well ventilated room with a temperature of between 0 and 40°C.
- The devices must not be covered during operation.
- Select the set-up site so that the devices are not exposed to direct sunlight.
- Place the devices on a stable and even surface with sufficient space.
- Make sure that no liquids can be poured over the devices or the power cord.
- Route the cables so that they are not subjected to tensile loading.
- Route the cables so that no one can trip over them.

### 6.1.2. Connecting the charging station to the power supply

<b>NOTICE</b>	
	<p><b>Damage caused by excessively high voltages or currents.</b></p> <ul style="list-style-type: none"> <li>▶ Use the power supply Vectron PS80 or another Vectron-approved power supply.</li> <li>▶ Use an earthed socket to which alternating current between 110 and 240 volts is connected.</li> <li>▶ Use power sources which are protected with a residual-current circuit breaker.</li> </ul>

- Put the power supply plug into the power connector of the charging station.

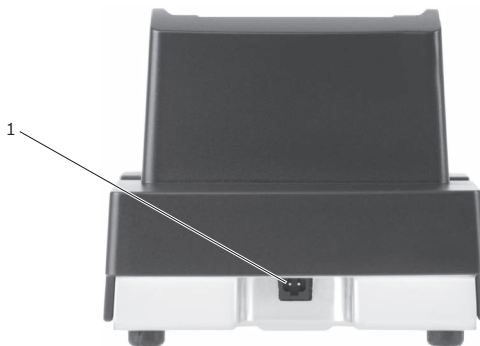

Fig. 17: Power connector of charging station

Pos.	Designation	Description
1	Power connection	Connector for power supply plug.

- Insert the Euro plug of the power supply to a socket.

## 6.2. Inserting the battery to the POS MobilePro III and charging

Prior to starting the POS MobilePro III you have to charge the battery completely.

### 6.2.1. Inserting the battery

<b>NOTICE</b>	
	<p><b>Damage of POS MobilePro III caused by unsuitable battery</b></p> <ul style="list-style-type: none"><li>▶ Use exclusively the Vectron B60 battery.</li></ul>



Fig. 18: Opening the locking of the battery compartment lid

- Open the battery compartment by folding up the locking of the battery compartment lid.



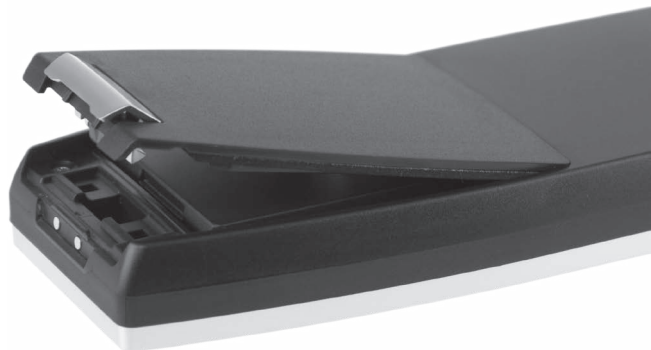

Fig. 19: Battery compartment lid open

- Fold up the battery compartment lid.
- Put it aside.



Fig. 20: Inserting the battery

- Insert the battery to the compartment.
- Press down the battery.



Fig. 21: Inserted battery

- Put back the battery compartment lid as described in Fig. 19 “Battery compartment lid open” on page 49.
- Fold down the battery compartment lid.
- Close the battery compartment lid by pressing down the locking until it snaps.

### 6.2.2. POS MobilePro III Charging the battery



The complete charging of an empty battery in the POS MobilePro III takes about 2.5 hours.



Fig. 22: POS MobilePro III in charging station.

Pos.	Designation	Description
1	Status LED (on upper edge of the POS system)	The status LED flashes green while the battery is being charged. When the battery is completely charged, the status LED is permanently green.

- Put the POS MobilePro III into the charging station.

## 7. Operation



In this chapter we describe an **example configuration** of the Vectron POS software. Programming and configuration of your POS system may differ considerably from your POS system. Your Vectron specialist retailer has programmed the POS MobilePro III for you and is your contact partner for questions concerning the programming.

### 7.1. Switching on and shutting down POS MobilePro III



#### 7.1.1. Switching on POS MobilePro III

If the POS MobilePro III was started as described in chapter in chapter 6 “Start-up” on page 46 you can switch on your POS system.

- Shortly press the on-/off key  at the bottom left on the keyboard to switch on the POS MobilePro III.

As soon as the registration surface is displayed, the POS MobilePro III is ready for operation.

#### 7.1.2. Shutting down POS MobilePro III



- Press simultaneously the on-/off key  at the bottom left on the keyboard and the soft key  on top right on the keyboard until the status LEDs shine blue and red and the vibration motor is released briefly.
- Release both keys.

The message „The system will shut down“ is displayed. As soon as the status LEDs go out, the POS MobilePro III is switched off.

### 7.1.3. Hardware reset

<b>NOTICE</b>	
	<p><b>Data loss through hardware reset</b></p> <p>Since the system is not shut down properly with a hardware reset, this can cause data loss.</p> <p>► Only use the hardware reset when the system cannot be shut down.</p>

In order to switch off the POS system independent of the POS software you can carry out a hardware reset.

- Press simultaneously the on-/off key  at the bottom left on the keyboard and the soft key  on top right on the keyboard.
- Keep the key combination pressed even after the vibration alarm.

As soon as the display is out, the POS MobilePro III is switched off.

## 7.2. Idle mode

### 7.2.1. Switching the Vectron POS MobilePro III to idle mode

Power consumption of the POS MobilePro III is reduced in idle mode because the screen is switched off.

- To switch the POS MobilePro III to idle mode keep the on-/off key  at the bottom left on the keyboard pressed until the screen is switched off.

The POS MobilePro III is switched to idle mode. The status LED slowly flashes green.



Your Vectron dealer can program your POS MobilePro III so that the POS software shuts down when you keep the on-/off key  pressed for some seconds.

### 7.2.2. Activating the Vectron POS MobilePro III from idle mode

- Shortly press the on-/off key  at the bottom left on the keyboard.

As soon as the registration surface is displayed, the POS MobilePro III is ready for operation.

### 7.3. Sign in to the POS MobilePro III

	<p>Buttons that are mentioned in this chapter and that can be displayed as graphical elements, are shown in chapter "12. Icons" on page .</p>
-----------------------------------------------------------------------------------	-----------------------------------------------------------------------------------------------------------------------------------------------

#### 7.3.1. Sign in via operator button

<b>NOTICE</b>	
	<p><b>Damage of touch screen caused by unsuitable objects.</b></p> <p>► Touch the screen exclusively with the provided stylus or with your fingers.</p>

- Enter the operator number to the keyboard.
- Press the grey field on top left in the status display (see in chapter 4.2.1.1 "Touch screen (example configuration)" on page 19).
- Enter the secret code if it is required.
- To sign in the operator press the Enter key for confirmation (see in chapter 4.2.1.2 "Keyboard" on page 21).

#### Sign out

- To sign out the signed-in operator press on his name in the status display.

## 7.3.2. Sign in via RFID card

- Hold the RFID card to the rear of the POS MobilePro III .
- Enter the secret code if it is required.
- To sign in the operator press the Enter key for confirmation.

### Sign out

- To sign out the signed-in operator hold the RFID card to the rear of the POS MobilePro III.

## 7.4. Data input to the POS MobilePro III

After having started and switched on the POS MobilePro III your POS system is ready for data input.

Data can be entered via touch screen (see in chapter 4.2.1.1 “Touch screen (example configuration)” on page 19) or via keyboard (see in chapter 4.2.1.2 “Keyboard” on page 21).

<b>NOTICE</b>	
	<p><b>Damage of touch screen caused by unsuitable objects.</b></p> <ul style="list-style-type: none"><li>▶ Touch the screen exclusively with the provided stylus or with your fingers.</li></ul>



## 7.5. Working with guest checks (GC)

The GC function serves for invoicing groups or single persons.

Your Vectron specialist retailer will support you with the programming of required functions.



Buttons that are mentioned in this chapter and that can be displayed as graphical elements, are shown in chapter 13 "Icons" on page 94.

### 7.5.1. Opening a guest check

In order to store GC bookings you first have to open a guest check.

GCs that already contain bookings but were not yet invoiced (open GCs), can be opened again with this function.

- Enter the GC number to the keyboard.
- Press the <GC> button  to open the guest check.

or

- Press the button <GC func.>
- Press the button <GC list>

The list of open GCs is displayed.

- To re-open a GC press on the respective entry in the list.



It depends on your operator rights whether you can just open your own GCs or those of other operators as well.

### 7.5.2. Booking PLUs to a GC

- Open the GC to which you want to enter PLUs as described in chapter 7.5.1 “Opening a guest check” on page 57.
- Select main group Food or main group Drinks.
- Select the department.
- Press the desired PLUs on the PLU selection list.

Behind the PLU entry you see the selected count.

- To book the PLUs press the selection button .

or

- For multiple booking of a PLU you can enter the desired number on the keyboard and select the respective PLU. The display shows the sum of desired PLUs.

### 7.5.3. Closing a GC

When you close a GC, bookings for this GC are stored. There are several ways to close a GC.

- Press the <GC> button  .
- or
- Open a new GC as described in chapter 7.5.1 “Opening a guest check” on page 57.



If you close a GC to which no PLUs were booked it will not appear in the list of open GCs.

### 7.5.4. Finalizing a GC

Various media are available for finalization. The GC is closed after finalization and no longer appears in the list of open GCs. The bookings are stored in the journal. The receipt to be printed depends on the programming.

## 7.5.4.1. Cash payment

### Example 1: The customer pays the exact amount:

- Open the GC that you want to finalize as described in chapter 7.5.1 “Opening a guest check” on page 57
- Press the <Media> button .
- Press the <Cash> button.

### Example 2: POS system calculates the change:

- Open the GC that you want to finalize as described in chapter 7.5.1 “Opening a guest check” on page 57.
- Enter the amount you got from the customer on the keyboard.



Please note that the amount has to be entered in cent here.  
50 € have to be entered as 5000.

- Press the <Media> button .
- Press the <Cash> button.

The change amount is displayed.

### 7.5.4.2. Other media

It depends on the programming of your POS MobilePro III whether you can use this function.

- Open the GC that you want to finalize as described in chapter 7.5.1 "Opening a guest check" on page 57
- Press the <Media> button .
- Press the respective credit card button.

### 7.5.5. Separate invoicing of groups or single persons



The GC split function can only be carried out if all PLUs of the GC have been booked. Close the open GC as described in chapter 7.5.3 "Closing a GC" on page 59.

- If a GC is open, close it as described in chapter 7.5.3 "Closing a GC" on page 59.
- Open the GC that you want to split as described in chapter 7.5.1 "Opening a guest check" on page 57.
- Press the button <GC func.>
- Press the button <GC split>.
- Select the PLUs to be split on the list. The respective PLU will be moved down.
- After having selected all the required PLUs press the button <Media> .
- Press the <Cash> button or select another media to invoice the split PLUs.

### 7.5.6. Splitting single PLUs to another guest check

The GC split function serves for transferring single PLUs of one guest check to another.



The GC split function can only be carried out if all PLUs of the GC have been booked. Close the open GC as described in chapter 7.5.3 "Closing a GC" on page 59.

- If a GC is open, close it as described in chapter 7.5.3 "Closing a GC" on page 59.
- Open the GC that you want to split as described in chapter 7.5.1 "Opening a guest check" on page 57.
- Enter the GC no. to which the PLUs are to be transferred.
- Press the button <GC func.>
- Press the button <GC split>.
- Press the PLUs you want to split on the list. The respective PLU will be moved down.
- After having selected all the required PLUs close the window.

The selected PLUs will be transferred.

The GC to which the PLUs were transferred is opened.

### 7.5.7. Moving all PLUs to another guest check

The GC move function serves for transferring all PLUs of one guest check to another.



The GC move function can only be carried out if all PLUs of the GC have been booked. Close the open GC as described in chapter 7.5.3 "Closing a GC" on page 59.

- If a GC is open, close it as described in chapter 7.5.3 "Closing a GC" on page 59.
- Open the GC that you want to move as described in chapter 7.5.1 "Opening a guest check" on page 57.
- Enter the GC no. to which the PLUs are to be moved.
- Press the button <GC func.>
- Press the button <GC move>.

All PLUs of the open GC are moved to the selected GC.

### 7.5.8. Transfer GC

This function serves for transferring a guest check to another operator.

This function can be enabled optionally.

Your Vectron specialist retailer will support you with the programming of required functions.

### **7.6. Working with hold buffers**

The hold buffer function allows several operators to work simultaneously at one POS system.

The first operator opens a hold buffer, signs in and books the PLUs. If a second operator wants to use the POS system in the meantime, he presses a new hold buffer button, signs in and books the PLUs. The operators' bookings are stored in the respective hold buffer until media finalization.

This function can be enabled optionally.

Your Vectron specialist retailer will support you with the programming of required functions.

### **7.7. Working with reports**

Reports serve for evaluating data that was stored in the POS system.

With Vectron POS software you can create two types of reports: X-reports and Z-reports. Z-reports are final reports where the data is deleted from the booking memory. X-reports are intermediate reports, where the data is just polled.

This function can be enabled optionally.

### **7.8. Correction or void last entry**

This function can be enabled optionally.

Your Vectron specialist retailer will support you with the programming of required functions.



## 7.9. Offline guest checks

In an ECR network, this function serves for reserving GCs for a defined time for exclusive operation by one POS system.

For example you can assign defined GCs to the POS MobilePro III prior to leaving the WiFi range. This can either be made manually or automatically on sign-in of the operator. As a result, the operator will always find his GC range in the POS MobilePro III. This GC range is blocked for other POS systems or other operators for the time being.

If the operator wants to release his GC range again, this can also be made manually or automatically with his sign-out.

Your Vectron specialist retailer will support you with installation and programming of the required functions.

## 7.10. Charging and exchanging the battery

### 7.10.1. Charging the battery

The POS MobilePro III displays the message „Charge battery“ when the capacity of the inserted battery is too low.

The POS MobilePro III switches off when the battery charging is below minimum.

	<p>Observe the information in chapter 7.10.5 “Prolonging the battery service life” on page 71.</p>
-----------------------------------------------------------------------------------	----------------------------------------------------------------------------------------------------

### 7.10.2. Charging the battery in the charging station

See the instructions in chapter 6.2 “Inserting the battery to the POS MobilePro III and charging” on page 48.

### 7.10.3. Charging the batteries in the battery charging station

<b>NOTICE</b>	
	<p><b>Damage caused by excessively high voltages or currents.</b></p> <ul style="list-style-type: none"><li>▶ Use the power supply Vectron PS80 or another Vectron-approved power supply.</li><li>▶ Use an earthed socket to which alternating current between 110 and 240 volts is connected.</li><li>▶ Use power sources which are protected with a residual-current circuit breaker.</li></ul>

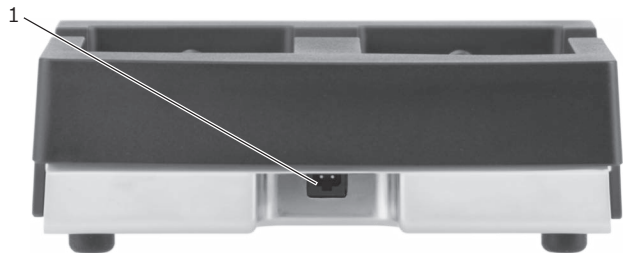

Fig. 23: Power connector of battery charging station

Pos.	Designation	Description
1	Power connection	

### NOTICE



**Damage of battery charging station caused by unsuitable battery**

- Use exclusively Vectron B60 batteries.



One battery charging station charges up to two batteries simultaneously.



The complete charging of an empty battery in the battery charging station takes about 2.5 hours.

- Put the plug of the power supply PS80 into the power connector of the battery charging station.
- Insert the Euro plug of the power supply PS80 to a socket.

- Insert the battery to the battery compartment.



Fig. 24: Inserting the battery to the compartment

- Press down the battery.



Fig. 25: Battery charging station with inserted battery

	<p>Out of a temperature range of ca. 5° to 40° C the battery charging station will interrupt the charging. A warning appears in the display.</p>  <p>The charging will be continued automatically when the temperature is adjusted.</p>
--	----------------------------------------------------------------------------------------------------------------------------------------------------------------------------------------------------------------------------------------------------------------------------------------------------------------------------

#### 7.10.4. Exchanging the battery in the POS MobilePro III

<b>NOTICE</b>	
	<p><b>Damage of POS MobilePro III caused by unsuitable battery</b></p> <ul style="list-style-type: none"> <li>▶ Use exclusively the Vectron B60 battery.</li> </ul>

	<p>If the battery is exchanged too quickly (&lt;3 seconds) the integrated battery protection circuit will not always recognize the exchange correctly. The POS MobilePro III does not start and by mistake may warn of too low battery.</p> <ul style="list-style-type: none"> <li>▶ Remove the battery for more than three second or put the POS MobilePro III into the charging station. The POS MobilePro III will then recognize the battery correctly.</li> </ul>
-----------------------------------------------------------------------------------	------------------------------------------------------------------------------------------------------------------------------------------------------------------------------------------------------------------------------------------------------------------------------------------------------------------------------------------------------------------------------------------------------------------------------------------------------------------------

- Switch off the POS MobilePro III as described in chapter 7.1.2 “Shutting down POS MobilePro III” on page 52.



Fig. 26: Opening the locking of the battery compartment lid

- Open the battery compartment by folding up the locking of the battery compartment lid.

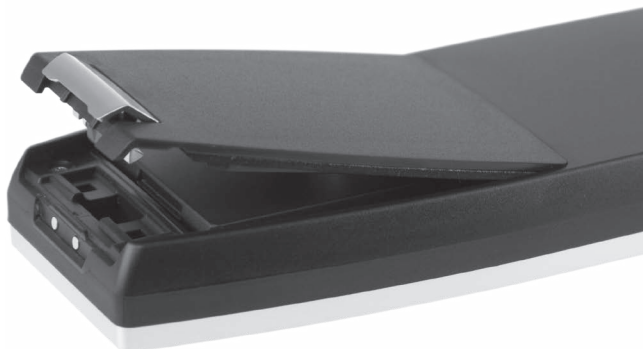

Fig. 27: Battery compartment lid open

- Fold up the battery compartment lid.
- Put it aside.



Fig. 28: Inserted battery

- At the bottom of the battery housing you find a grip (see in chapter 4.7 “Battery Vectron B60” on page 36). Take the

grip and pull the battery to the top.



Fig. 29: Removing the battery

- Remove the battery.
- Insert the new battery to the compartment.
- Press down the battery.
- Put back the battery compartment lid as described in Fig. 27 “Battery compartment lid open” on page 70.
- Fold down the battery compartment lid.
- Close the battery compartment lid by pressing down the locking until it snaps.

#### 7.10.5. Prolonging the battery service life

The battery is a chargeable lithium-polymer battery.

If the battery capacity is below a defined minimum value, the spare capacity is indicated on every start of the POS system.

If the spare capacity is exhausted as well, the POS system is shut down after a respective warning.



- Run-down or faulty batteries cannot be repaired.
- Please dispose of run-down or faulty batteries properly.

Tips for a long battery service life:

- Use the batteries until the POS MobilePro III signals the discharge: either by fading in „Charge battery“ or when the bar for charge indication turns red.
- Always charge the batteries in the charging station completely.
- Batteries that are not used for a longer period (approx. 2 - 3 months) should be charged 40-50 %. For this purpose, the discharged battery needs to be charged for about 40 minutes. Do not store the battery in the battery charging station afterwards.

### 7.11. MicroSD card

The POS MobilePro III has an installed MicroSD card slot. You can use a MicroSD card e.g. for loading a backup or an update or for storing a backup.

#### 7.11.1. Inserting the MicroSD card

Proceed as follows to insert a MicroSD card to the card reader:

- Remove the battery as described in chapter 7.10.4 “Exchanging the battery in the POS MobilePro III” on page 69.
- Take the MicroSD card so that the contacts are on top.
- Slide the MicroSD card into the card reader, the chip to the front until it locks in (see in chapter 4.2.5 “Battery compartment” on page 25).
- Insert the battery and close the POS MobilePro III as described in chapter 7.10.4 “Exchanging the battery in the POS MobilePro III” on page 69.



### 7.11.2. Removing the MicroSD card

To remove the MicroSD card you require a pair of tweezers.

- Remove the battery as described in chapter 7.10.4 “Exchanging the battery in the POS MobilePro III” on page 69.
- Push the MicroSD card a bit into the card reader. The „Push-Push“ mechanism pushes the MicroSD card some millimetres out of the card reader.
- Take the card with the tweezers and take it out of the card reader.
- Insert the battery and close the POS MobilePro III as described in chapter 6.2.1 “Inserting the battery” on page 48.

## 7.12. WLAN (Wireless Local Area Network)

The POS MobilePro III has a WLAN module for wireless network communication.

Your Vectron specialist retailer will support you with the WLAN installation and programming of required functions.



In an ECR network the same Vectron POS software version has to be installed on all the POS systems.



The POS MobilePro III supports the safety standards WEP and WPA2 for data encryption.

### NOTICE



#### **External access to your data**

- ▶ Make sure that your WLAN has switched on the latest available encryption standard (WPA2).

For the wireless connection to other network devices you can program two operation modes:

- In ad-hoc mode, the POS MobilePro III establishes a direct connection to another device, e.g. a printer with WLAN module. WLAN modules are available as accessories.
- In infrastructure mode, an access point must be available and configured to use a wireless network. The access point rules the communication between devices in wireless networks.

The POS MobilePro III can communicate alternately with 16 access points within a Wireless LAN. It independently selects the access point with the strongest radio signal.

The network name, the so-called SSID of the access points, must not be hidden, since otherwise the POS MobilePro III cannot establish communication.



We recommend positioning the access points at a height of at least two metres.

The access points antennas must be adjusted in such a way that they can receive radio signals of the POS MobilePro III from the complete radius of the operator.

The range of the integrated WLAN module is ca. 50 metres in closed rooms and ca. 50 metres outdoor. Obstacles reduce the range or can interrupt the connection.

The POS MobilePro III re-establishes radio connection when returning to the WLAN radio network and transmits the buffered data.

By means of the Vectron Commander you can retrieve booking data via the WLAN connection and update the Vectron POS software.

### 7.13. Bluetooth

Your Vectron specialist retailer will support you with the Bluetooth installation and programming of required functions.



Using the Bluetooth module requires an additional licence. Please contact your Vectron dealer.

The integrated Bluetooth radio module serves for communication with peripherals via short distances. Via this radio connection the POS MobilePro III can contact printers, scanners etc. that are equipped with Bluetooth technology.

The range of this connection is about five metres. Obstacles reduce the range or can interrupt the connection.

### **7.14. Print data server**

Each POS system in network can be programmed to work as print data server in addition to the POS system function.

A print data server serves for receiving print data from another POS system in network, for processing them and printing them on a locally connected printer.

You can install several print data servers. Orders that you enter to your POS MobilePro III can be printed automatically in the kitchen for example. After the payment the POS system can print the invoice automatically at the counter for example.

Your Vectron specialist retailer will support you with the programming of your POS systems and the installation of required devices.

## 8. Service and maintenance

<b>⚠ DANGER</b>	
	<p><b>Danger through electric shock at power cord and power supply!</b></p> <ul style="list-style-type: none"> <li>▶ Do not clean charging station, battery charging station and power supply when the Euro plug is plugged in.</li> <li>▶ Do not open charging station, battery charging station and power supply.</li> </ul>

### 8.1. Cleaning

#### 8.1.1. Cleaning housing and display

<b>NOTICE</b>	
	<p><b>Aggressive cleansers can damage the housing surface.</b></p> <ul style="list-style-type: none"> <li>▶ Do not use any scouring or dissolving agents for cleaning.</li> <li>▶ If necessary clean the housing surface with a smooth, lint-free cloth. In case of strong contamination you can dampen the cloth with water or with a mild, residue-free cleanser.</li> </ul>

### 8.1.2. Cleaning the keyboard

You can remove the keyboard for cleaning. For this purpose you don't have to open the POS MobilePro III.

<b>NOTICE</b>	
	<b>Damage of keyboard grid and housing caused by lever.</b> ▶ Use a plastic screw driver as lever.



Fig. 30: Notch in keyboard grid

Pos.	Designation	Description
1	Notch	For attaching a lever to release the keyboard grid.

- Attach the tip of the lever to the notch.

- Carefully lift the keyboard grid.



Fig. 31: Released keyboard grid

- Remove the keyboard grid.



Fig. 32: Removed keyboard grid

You see 20 key caps applied on a keyboard map.

	The key caps are not fixed.
-----------------------------------------------------------------------------------	-----------------------------

- Carefully take the caps from the keyboard map.
- Clean them with a brush or lint-free cloth. Observe the information in chapter 8.1.1 “Cleaning housing and display” on page 77
- Put back the key caps. For the correct arrangement of keys please see in chapter 4.2.1.2 “Keyboard” on page 21.
- Align the keyboard grid as shown in Fig. 31 “Released keyboard grid” on page 79.

<b>NOTICE</b>	
	<b>Damage of keyboard mat or malfunctions caused by jammed key caps</b> ▶ When inserting the keyboard grid make sure that the key caps are properly led through the grid.

- Carefully press down the keyboard grid until it locks in place as shown in Fig. 30 “Notch in keyboard grid” on page 78.
- Check the key caps for proper seating and mechanical function.



### **8.1.3. Cleaning the contacts**

Corroded and soiled contacts impede the current flow and can lead to prolonged charging times and reduced charging capacity.

Clean the contacts of the POS MobilePro III, charging station, battery charging station and batteries regularly with a spirit-soaked cotton bud and without applying pressure.

## **8.2. Contacting the customer service**

Your Vectron dealer will answer your questions concerning the POS MobilePro III and peripherals and will support you with configuration and operation.

## 9. Errors, possible reasons and troubleshooting

### 9.1. POS MobilePro III

Errors	Possible reasons	Troubleshooting
The POS MobilePro III cannot be switched on.	No battery inserted in the compartment of the POS MobilePro III	Insert a battery to the compartment of the POS MobilePro III as described in chapter 6.2.1 "Inserting the battery" on page 48.
	The battery is not charged.	Charge a battery as described in chapter 7.10.3 "Charging the batteries in the battery charging station" on page 66 or in chapter 6.2.2 "POS MobilePro III Charging the battery" on page 51.
	The Vectron POS software has a malfunction.	Switch off the POS MobilePro III as described in chapter 7.1 "Switching on and shutting down POS MobilePro III" on page 52.
	The On/Off key is damaged.	Contact your Vectron dealer.
	The POS MobilePro III is damaged.	Contact your Vectron dealer.
	The battery is damaged.	Contact your Vectron dealer.

Errors	Possible reasons	Troubleshooting
The POS MobilePro III does not react to your entries.	The POS MobilePro III is switched off or in idle mode.	Press the On/Off key as described in chapter 7.1.1 "Switching on POS MobilePro III" on page 52.
	The signed-in operator is not authorized for the respective function.	Contact your Vectron dealer.
	The Vectron POS software has a malfunction.	Switch off the POS MobilePro III as described in chapter 7.1 "Switching on and shutting down POS MobilePro III" on page 52.
	Faulty programming of MobilePro III.	Contact your Vectron dealer.
	The touch screen is damaged.	Contact your Vectron dealer.
	The POS MobilePro III is damaged.	Contact your Vectron dealer.
	The battery is damaged.	Contact your Vectron dealer.
The POS MobilePro III does not display anything.	The POS MobilePro III is switched off or in idle mode.	Press the On/Off key as described in chapter 7.1.1 "Switching on POS MobilePro III" on page 52.
	No battery inserted in the compartment of the POS MobilePro III.	Insert a battery to the compartment of the POS MobilePro III as described in chapter 6.2.1 "Inserting the battery" on page 48.

## POS MOBILEPRO III

---

Errors	Possible reasons	Troubleshooting
	The battery is not charged.	Charge a battery as described in chapter 7.10.3 "Charging the batteries in the battery charging station" on page 66 or in chapter 6.2.2 "POS MobilePro III Charging the battery" on page 51.
	The Vectron POS software has a malfunction.	Switch off the POS MobilePro III as described in chapter 7.1 "Switching on and shutting down POS MobilePro III" on page 52.
	The POS MobilePro III is damaged.	Contact your Vectron dealer.
	The battery is damaged.	Contact your Vectron dealer.
The POS MobilePro III processes other entries than those made on the touch screen.	The touch screen is damaged.	Contact your Vectron dealer.
The battery is discharged after a short time.	The battery is not charged completely.	Discharge the battery completely. Charge the battery again as described in chapter 7.10.3 "Charging the batteries in the battery charging station" on page 66 or in chapter 6.2.2 "POS MobilePro III Charging the battery" on page 51.

Errors	Possible reasons	Troubleshooting
	The battery has reached the maximum number of charging cycles as described in chapter 5.2 "Battery B60" on page 38.	Exchange the battery.
The POS MobilePro III does not send data to the access point.	Obstacles interrupt the connection to the access point.	
	The access point is switched off.	Switch on the access point.
	The POS MobilePro III is out of the radio signal range.	Bring the POS MobilePro III to radio signal range or expand the range of your WLAN. Contact your Vectron dealer.
	Faulty configuration of the access point.	Contact your Vectron dealer.
	The radio signal is disturbed by devices within its range.	Contact your Vectron dealer.
	The access point is damaged.	Contact your Vectron dealer.
	The POS MobilePro III is damaged.	Contact your Vectron dealer.



## 9.2. Charging station

Errors	Possible reasons	Troubleshooting
The battery is not charged when the POS MobilePro III is in the charging station.	The Euro plug of the power supply Vectron PS80 is not plugged to a voltage-carrying outlet.	Insert the Euro plug of the power supply to a voltage-carrying outlet.
	The power supply plug is not put into the power connector of the charging station.	Put the power supply plug into the power connector of the charging station.
	The charging contacts of the POS MobilePro III do not contact those of the charging station.	Put the POS MobilePro III into the charging station so that the charging contacts touch each other. Clean the charging contacts as described in chapter 8.1.3 "Cleaning the contacts" on page 81.
	The temperature of the battery is above or below the permissible temperature range. The display for the charging state has a red frame and an error message appears.	Make sure that the ambient temperature is as described in chapter 5.2 "Battery B60" on page 38. Wait until the battery temperature is in the permissible range.
	The power supply that is connected to the charging station is not approved by Vectron.	Connect the Vectron PS80 or another approved power supply to the charging station.
	The battery is damaged.	Contact your Vectron dealer.

Errors	Possible reasons	Troubleshooting
	The POS MobilePro III is damaged.	Contact your Vectron dealer.
	The power supply is damaged.	Contact your Vectron dealer.
	The charging station is damaged.	Contact your Vectron dealer.

### 9.3. Battery charging station

Errors	Possible reasons	Troubleshooting
The batteries are not charged when being inserted to the battery charging station.	The Euro plug of the power supply is not plugged to a voltage-carrying outlet.	Plug in the Euro plug.
	The power supply plug is not put into the power connector of the battery charging station.	Plug in the power supply plug.
	The battery contacts do not contact those of the battery charging station. A warning appears in the display  .	Put the battery into the battery charging station so that the charging contacts touch each other. Clean the charging contacts as described in chapter 8.1.3 "Cleaning the contacts" on page 81.

Errors	Possible reasons	Troubleshooting
	The temperature of the battery is above or below the permissible temperature range. A warning appears in the display  .	Make sure that the ambient temperature is as described in chapter 5.2 "Battery B60" on page 38. Wait until the battery temperature is in the permissible range.
	The power supply that is connected to the battery charging station is not approved by Vectron.	Connect the Vectron PS80 or another approved power supply to the battery charging station.
	The battery is damaged. A warning appears in the display  .	Contact your Vectron dealer.
	The power supply is damaged.	Contact your Vectron dealer.
	The battery charging station is damaged.	Contact your Vectron dealer.

#### 9.4. Power supply failure

All the data in the POS MobilePro III is protected in case of sudden power supply failure (e.g. removal of battery). This is guaranteed by an integrated system battery, which supplies the POS system's data memory with minimum current.

The service life of this battery is at least five years.



## 10. Shutdown

<b>NOTICE</b>	
	<p><b>Damage of battery cells caused by total discharge</b></p> <ul style="list-style-type: none"><li>▶ Check the charging state of the stored batteries by means of the display on the POS MobilePro III.</li><li>▶ Charge the batteries for 40-50 percent after six months at the latest.</li></ul>

Shut down the POS MobilePro III, charging station and battery charging station if you do not use it for a longer time.

### 10.1. Shutting down the POS MobilePro III

- Switch off the POS MobilePro III as described in chapter 7.1.2 “Shutting down POS MobilePro III” on page 52.
- Remove the battery as described in chapter 7.10.4 “Exchanging the battery in the POS MobilePro III” on page 69.
- Pack the POS MobilePro III and the battery in the original packaging.
- Store the POS MobilePro III in a room where the temperature is -20 to 70 °C and air humidity between 10 and 80 percent.
- Store the battery in a room where the temperature is -20 to 60 °C and air humidity between 45 and 85 percent. The optimum storage temperature for the battery is 20 to 25°C.

### **10.2. Shutting down charging station or battery charging station**

- Unplug the Euro plug of the power supply from the socket.
- Unplug the power supply connector.
- Pack the charging station or battery charging station and the power supply in the original packaging.
- Store the charging station or battery charging station in a room where the temperature is -20 to 70 °C and air humidity between 10 and 80 percent.
- Store the power supply in a room where the temperature is -10 to 70 °C and air humidity between 50 and 90 percent.

# 11. Disposal

## Directive 2012/19/EU (WEEE)



Waste electric and electronic equipment must not be disposed of together with domestic waste. Vectron Systems AG takes back waste electric and electronic equipment that has been used for commercial purposes and that was produced by or on behalf of the company. The company disposes of the waste electric and electronic equipment properly.

The legal take-back obligation applies for devices that were put on the market after 13 August 2005. In addition, Vectron Systems AG extends this obligation to all devices that were put on the market since 1 January 2004.

Please send back waste electric and electronic equipment that was produced by or on behalf of Vectron Systems AG as well as their accessories in the original packaging, marked „Waste electric and electronic equipment“ franco domicile to Vectron Systems AG.  
**WEEE-Reg.-Nr. DE 91733199**

## Directive 2006/66/EG



Dispose of exhausted batteries in suitable collection facilities. Within the European Union, batteries and accumulators can be brought to respective municipal collection points free of charge.

The symbol means: Do not dispose of batteries and accumulators together with domestic waste.

The following symbols may appear:

Cd = contains more than 0.002 percent cadmium by weight

Hg = contains more than 0.005 percent mercury by weight

Pb = contains more than 0.004 lead by weight.

## 12. Glossary

This chapter explains the terms that are used in context with the POS MobilePro III.

Term	Definition
Access Point	Device that can communicate via radio with several mobile POS systems.
Bar code	Information, which consists of bars with various widths and spaces of parallel lines. The bar code represents data, which e.g. the POS system can decode.
Bluetooth	Wireless technology standard for exchanging data over short distances. Via Bluetooth network you can address devices like for example printers.
Button	A button is programmed in the POS system and releases commands. The programmed commands can be called via touch screen or keyboard of the POS system.
CE	A manufacturer confirms with the CE-mark that his products were produced in accordance with the respective EU-standards and directives. The acronym CE means Communauté Européenne.
Flash memory	Memory in which data is kept even after the voltage supply was switched off.
GC server	POS system, which in the ECR network takes over the central guest check management.
Icon	Pictograph used in graphical user interfaces. When touching or clicking on icons you call functions of the Vectron POS software.
LCD	Liquid Crystal Display
Media	Method for finalizing an invoice. Media are for example cash- and credit card payment.
POS	Point Of Sale. In this context the POS system station.



















Term	Definition
Router	Tool that rules the communication between devices in wired networks.
Softkeys	Keys of the POS MobilePro III, to which you can assign functions.
SSID	SSID (Service Set Identifier) is the name of a wireless network.
TFT (Thin Film Transistor)	Electronic component for control of screens.
Touchscreen	Touchscreen with entry function.
Transponder	Device for wireless communication.
Wireless network	see WLAN
WLAN (Wireless Local Area Network)	Wireless radio network for devices. The devices can transmit data via WLAN. To use WLAN an access point must be installed and configured.
X-report	Intermediate report, where data is kept in the booking memory of the POS system.
Z-report	Final report where the data is deleted from the booking memory.





























# 13. Icons

Icons are graphics that symbolize defined functions. Icons mark defined spaces on the screen, which are called buttons.

By touching the buttons on the screen of POS MobilePro III you call functions or select PLUs.

This chapter lists the icons integrated in Vectron POS software and explains their meaning. Furthermore, you can load additional icons.

Icon	Meaning	Icon	Meaning
	Clear		Seat number
	Escape		PLU
	Take away		Invoice
	Cancel receipt		Load invoice
	Receipt copy		Recall invoice
	Guest count		Invoice copy
	Inhouse		Seat split
	No invoice		Void
	Operator		Void last entry

Icon	Meaning	Icon	Meaning
	Manager functions only		GC
	Open GC/Operator		GC 0
	GC split		Side dishes
	Transfer GC		Beer
	GC moven		Icecream
	Table map		Fish
	Enter GC text		Meat
	X-report		Drinks
	Z-report		Main courses
	Subtotal GC		Desserts
	Subtotal		Pizza
	Cash		Spirits
	Cold drinks		Starters
	Hot drinks		Wine

# 14. EU Declaration of Conformity

Manufacturer                      Vectron Systems AG  
                                            Willy-Brandt-Weg 41  
                                            D-48155 Münster

Device type                        Mobile POS system  
Type designation                **Vectron POS MobilePro III  
incl. Vectron POS MobilePro III  
charging station**

The manufacturer declares that the above designated product consistent with directive 2001/95/EC complies with the fundamental standards on electrical and electronic products as stipulated in the directives of the European Council. The below mentioned standards that were harmonised under the relevant directives were applied:

Directive	Standards
2014/53/EG 2014/30/EU	EN 55022 cl. B:2010, EN301489-1, V.1.9.2 EN 55024:2010, EN 301 489-17, V.2.2.1 EN 61000-3-2:2014 EN 61000-3-3:2013 EN 60950-1:2006+A11:2009+A12:2011+A1: 2010+A2:2013 EN 62479:2010 EN 300 328 V1.9.1
2011/65/EU	EN 50581:2012

This declaration is made in authority for the manufacturer resident in the European Union.

Muenster, 2017-12-01

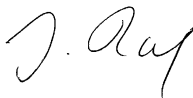

Jens Reckendorf  
Member of the Board



Thomas Stümmler  
Member of the Board



Manufacturer                      Vectron Systems AG  
                                             Willy-Brandt-Weg 41  
                                             D-48155 Münster

Device type                         Charging station  
 Type designation                 **Vectron POS MobilePro III**  
                                             **battery charging station**

The manufacturer declares that the above designated product consistent with directive 2001/95/EC complies with the fundamental standards on electrical and electronic products as stipulated in the directives of the European Council. The below mentioned standards that were harmonised under the relevant directives were applied:

Directive	Standards
2014/53/EG	EN 55022 cl. B:2010 EN 55024:2010

This declaration is made in authority for the manufacturer resident in the European Union.

Muenster, 2017-12-01

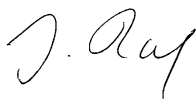

Jens Reckendorf  
Member of the Board



Thomas Stümmler  
Member of the Board

## 15. Accessories

At this point we would like to inform you about the accessories you can purchase for the POS MobilePro III. For more information and the technical data for accessories please see the website at [www.vectron.de](http://www.vectron.de).

For questions concerning our products please contact your Vectron dealer.

### 15.1. Battery B60

You can buy more batteries in addition to the one supplied with the POS MobilePro III.



Fig. 33: Battery B60

## 15.2. Charging station

In the charging station you can charge a battery installed in the POS MobilePro III.



Fig. 34: Charging station

### 15.3. Battery charging station

In the battery charging station you can charge up to two batteries simultaneously.



Fig. 35: Battery charging station

### 15.4. Connecting plate

Plate for connecting the groundplates of charging stations and battery charging stations.



Fig. 36: Connecting plate

## 15.5. Lancom WLAN Access Points

The WLAN Access Points Lancom L-151gn and L-321agn serve for wireless networking of POS systems.



Fig. 37: WLAN Access Point Lancom L-151gn



Fig. 38: WLAN Access Point Lancom L-321agn

### 15.6. Network print licence for WLAN

The network print licence for WLAN serves for printing from a POS MobilePro III on a WLAN printer.

### 15.7. Printer Bixolon SPP-R200II

The POS MobilePro III triggers the mobile thermal printer Bixolon SPP-R200II via Bluetooth.

You can attach the printer to your belt with a clip. The printer uses thermal paper.



Fig. 39: Printer Bixolon SPP-R200II

## 15.8. Epson printer TM-P20 WLAN

The TM-P20 WLAN EU and the TM20-P20 WLAN UK are mobile thermal printers.

The new Epson printer generation can be configured via App (Epson TM Utility), which is available for Android as well as for Apple devices.



Fig. 40: Epson printer TM-P20 WLAN

### 15.9. Leather holster

To protect the POS MobilePro III when in use we recommend a special leather holster. This holster can be attached to a suitable belt and allows carrying the POS MobilePro III conveniently at the hip.

The holster is made of robust calf leather.

The metal lug at the side serves for attaching a safety strap. The strap is attached to the POS MobilePro III by means of a safety swirl.



Fig. 41: Leather holster



### 15.10. Belt

You can attach the leather holster to the belt. The belt allows carrying the POS MobilePro III conveniently at the hip.



Fig. 42: Belt

### 15.11. Safety strap

<b>NOTICE</b>	
	<p>▶ Do not use any metal safety straps. These can scratch the housing of the POS MobilePro III irreparably when touching it.</p>

The safety strap prevents the POS MobilePro III from falling down.



Fig. 43: Safety strap

## 16. Other Vectron products

Here we would like to inform you about additional Vectron products. For more information and the technical data for Vectron products please see the website at [www.vectron-systems.com](http://www.vectron-systems.com).

For questions concerning our products please contact your Vectron dealer.

### 16.1. Stationary Vectron POS systems

Stationary Vectron POS systems with fast and reliable hardware are perfectly suited to single station use. Their special server attribute also allows data exchange with other stationary and mobile Vectron POS systems.

The large product range provides the ideal Vectron POS system for any application.

### 16.1.1. Vectron POS Touch 15, POS Touch 15 PCT, POS Touch 15 II PCT

Vectron POS Touch 15 / II PCT has a 38.1 cm display (15"). Data is entered via touch screen.



Fig. 44: Vectron POS Touch 15 / POS Touch 15 II PCT

### 16.1.2.Vectron POS Touch 12, POS Touch 12 II PCT

Vectron POS Touch 12 has a 30.7 cm display (12,1").  
Data is entered via touch screen.



Fig. 45: Vectron POS Touch 12

### 16.1.3. Vectron POS Vario II

Vectron POS Vario II has a 30.7 cm display (12,1"). Data is entered either via the flat keyboard or via touch screen.



Fig. 46: Vectron POS Vario II

## 16.1.4.Vectron POS Mini II

Vectron POS Mini II POS Mini II has a 17.8 cm display (7"). Data is entered either via the flat keyboard or via touch screen (when using the software light licence, data input is made exclusively via keyboard).



Fig. 47: Vectron POS Mini II

## 16.2. Software

### 16.2.1. Vectron Mobile App

The new ECR app for hospitality professionals is so easy to operate that you will be familiar with all the functions within minutes. At the same time the app provides you all the comfort you require for mobile cashing.

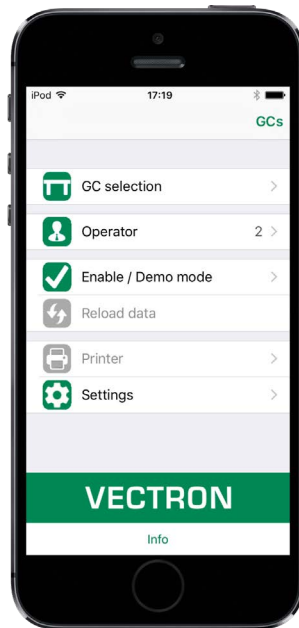

Fig. 48: Vectron Mobile App

### 16.2.2. Vectron Commander

The Commander is the communication- and evaluation software for Vectron POS systems. You can use the software on computers with operating system Microsoft® Windows®.

With the Vectron Commander you can retrieve, evaluate and manage the data of the Vectron POS systems. The software helps you get an overview on sales, order, and the working times of your staff.

Data can be sent to and received from several POS systems simultaneously.

Vectron Commander has an integrated user rights administration that allows you assigning individual rights for every user.

The POS Anywhere function enables you to connect via network or modem to POS systems and control them remotely and to monitor operating procedures.

The Commander can be used as interface between external like e.g. ERP systems and POS systems.



### **16.2.3. Vectron Journal Tool**

Vectron Journal Tool is a tool for evaluation, archiving and analysis for the POS system's journal data that was read by means of the Vectron Commander.

Companies of all trades profit from the comprehensive functions. All sales and transactions are displayed in detail. The respective transactions for each receipt (e.g. subtotal, split receipt, invoice) are displayed.

The software can be installed on common PCs by using a Microsoft SQL database.

### **16.2.4. Vectron POS PC**

POS PC is software that you can use on computers with operating system Microsoft® Windows®.

You can use the software in addition to the usual Windows applications like e-mail-, office- and ERP applications.

The POS PC software is compatible to all mobile and stationary POS systems, Vectron Commander and Vectron Journal Tool.

## **16.3. bonVito**

bonVito is Vectron's solution for customer loyalty. All customer retention promotions are conveniently processed automatically via the Vectron POS system during the payment process. bonVito provides individual customer cards, collection and redemption of points, digital stamps, payment function and coupons per e-mail, text message or receipt imprint.